

CCS Technical Documentation

NPM-8 Series Transceivers

10. Accessories

Contents

	Page No
BLC-1 Battery.....	5
ACP-7 Charger.....	6
ACP-8 Charger.....	7
ACP-12 Charger.....	8
DCV-10 Desktop Stand	9
DDC-1 Battery Charging Stand	10
LCH-9 Mobile Charger	11
PPH-1 Plug and Play Handsfree	12
MBC-6 Mobile Holder.....	13
HDE-2 Headset	14
HFM-8 Handsfree Microphone.....	15
HDC-5 Headset	16
LPS-3 Loopset.....	17
HDA-9 TTY Adapter	18
CARK-125 Express Car Kit.....	19
CARK-134 Car Kit	20

BLC-1 Battery

The BLC-1 is an 825 mAh lithium ion battery.

Product Code

Battery BLC-1:

0670428

View of Battery BLC-1

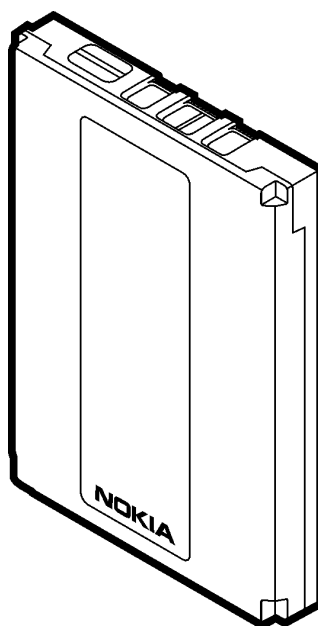

ACP-7 Charger

The standard charger is available can be used as a power supply for the basic stand and desktop stand.

View of ACP-7U Charger

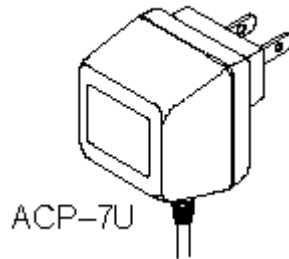

Product Code

AC Travel Charger (US plug) 108-132 Vac ACP-7U: 0675143

Specification

Output connectors:	<i>3.5 mm DC plug, 2-pole</i>
Protection:	PTC protection
Output Voltage /Current (typ)	7.6 V / 370 mA

ACP-8 Charger

Operating within the voltage range 90 V...264 V AC (50 Hz...60 Hz), the Performance Travel Charger is current-independent in normal office and household use. Like the standard charger, it is compatible with all battery options and is available for different wall sockets.

The ACP-8 Charger also may be used with desktop stand.

View of ACP-8U

ACP-8U

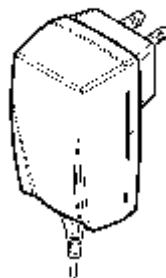

Product Code

Performance Travel Charger U.S. plug 90-264 Vac ACP-8U: 0675196

Specifications

Output connectors:	<i>3.5 mm DC plug, 2-pole (+, -, control)</i>
Protection:	Output fault voltage 16 V max
Output voltage/current (typ):	6.0 V (0.3 V)/ 620 mA

ACP-12 Charger

The ACP-12 charger is an AC switch mode mains power supply (SMPS). The charger supplies NMP cellular handportables and accessories. It has multivoltage AC mains input.

Product Code

Travel Charger (U.S.)

ACP12-U: 0675303

View of ACP-12U

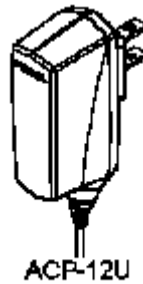

DCV-10 Desktop Stand

The desktop stand provides a convenient way to charge the phone in the upright position on a table.

Product Code

Desktop stand DCV-10: 0272865

View of DCV-10

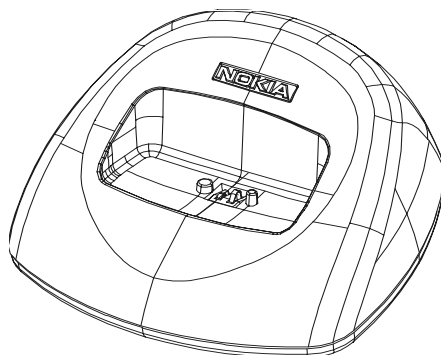

Specification

Connections: 3.5 mm DC jack (ACP-7 or ACP-8)

DDC-1 Battery Charging Stand

Supports BLB-2, BLB-3, BLL-2, BMC-2, BMC-3, BLC-1, and BLC-2 batteries. Compatible chargers: Standard Charger ACP-7, Travel Charger ACP-8, and Performance Travel Charger ACP-9.

Product Code

Battery Charging Stand DDC-1: 0675243

View of Battery Charging Stand (shown with battery)



Specifications

Dimensions (H x W x D):	31 x 62 x 105.5 mm
Weight:	97 g
Connections:	3.5 mm DC jack (ACP-7 or ACP-8)

LCH-9 Mobile Charger

The LCH-9 provides charging using the automobile cigarette lighter socket.

Product Code

Cigarette lighter charger LCH-9: 0675120

View of Cigarette Lighter Charger



Specifications

Connectors

- input:: *D 21/23 mm*
- output:: *3.5 mm DC plug*

Protection: *input fused, output current limit 850 mA*

Voltage

- input: *11...32 V*
- output (nominal): *8.4 V*

Nominal output current: *800 mA*

PPH-1 Plug and Play Handsfree

The PPH-1 provides rapid charging for the phone and makes handsfree operation possible. The PPH-1 plug and play handsfree unit is connected directly to the cigarette lighter in a car. The PPH-1 is connected to the mobile phone with the cable. The cable has combined the connector with the charger and headset connectors.

Product Code

PPH-1 Handsfree unit: 0675182

View of PPH-1

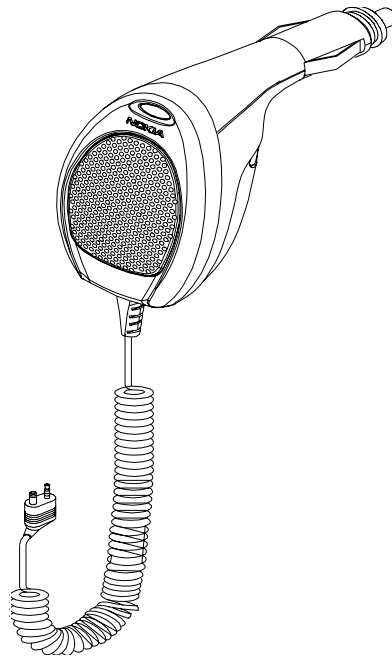

Specification

Output connectors:	3.5 mm DC plug, 2-pole (+, -, control)
Input Voltage:	8-16 VDC
Protection:	Output fault voltage 16 V max
Operation Current:	750 mA max

MBC-6 Mobile Holder

The MBC-6 Mobile Holder is used in vehicle to hold the phone. Attaching can be done using a swivel or mounting plate.

Product Code

Mobile Holder MBC-6: 0650026

View of MBC-6

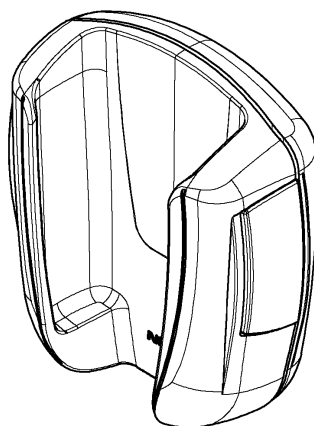

HDE-2 Headset

The HDE-2 is the standard headset. HDE-2 allows easy and convenient handsfree operation. It is equipped with a clip for a comfortable fit. The headset's 4-wire 2.5 mm jack fits directly into the bottom of the phone.

Product Code

HDE-2 Headset: 0694075

View of HDE-2

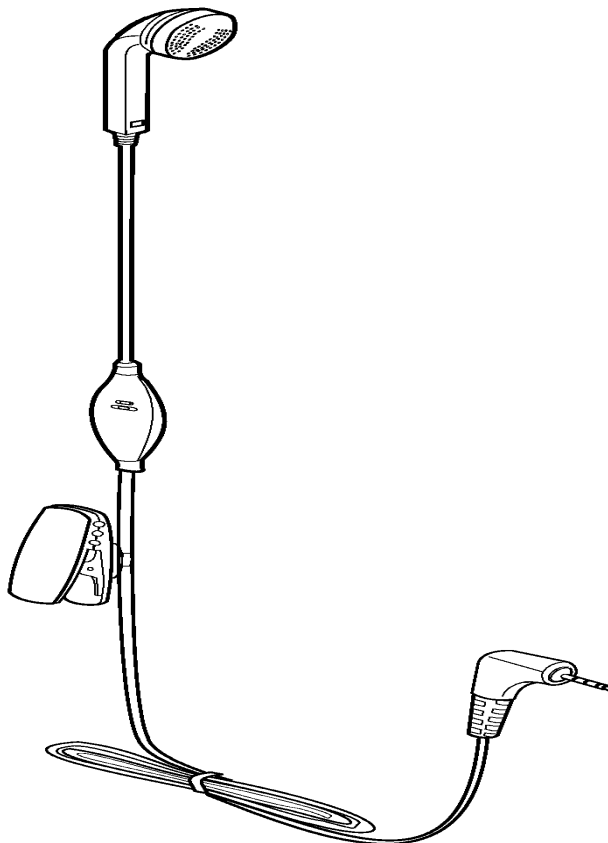

HFM-8 Handsfree Microphone

The HFM-8 microphone can be used together with the PPH-1 plug-and-play handsfree unit.

Product Code

HFM-8 Handsfree Microphone: 0690016

View of HFM-8

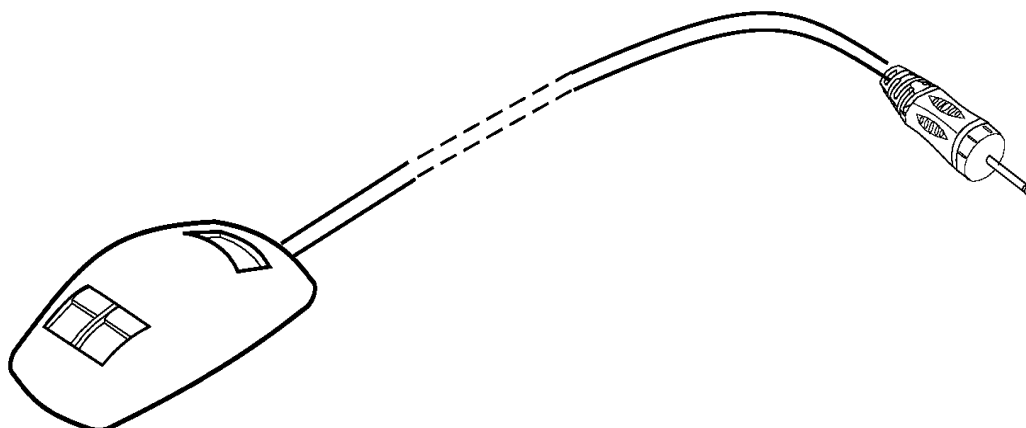

HDC-5 Headset

The HDC-5 headset also provides a hook switch for the answer/end call button.

Product Code

Headset HDC-5: 0694059

View of HDC-5

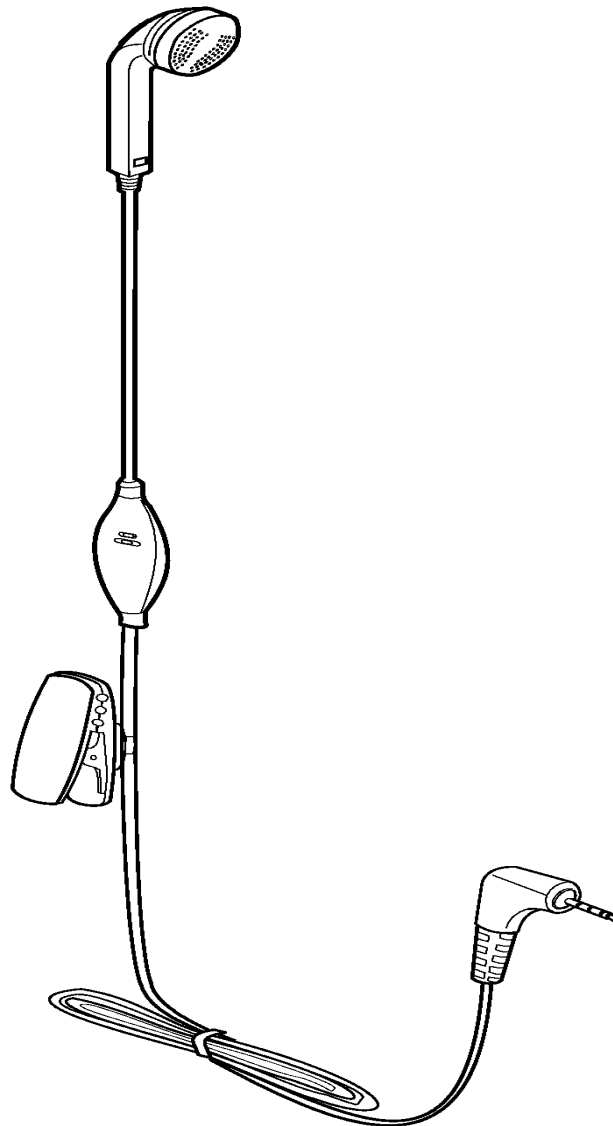

LPS-3 Loopset

The LPS-3 mobile loopset gives people with T-coil equipped hearing aids the ability to make and receive calls without noise interference.

Product Code

Loopset LPS-3: 0272512

View of Loopset

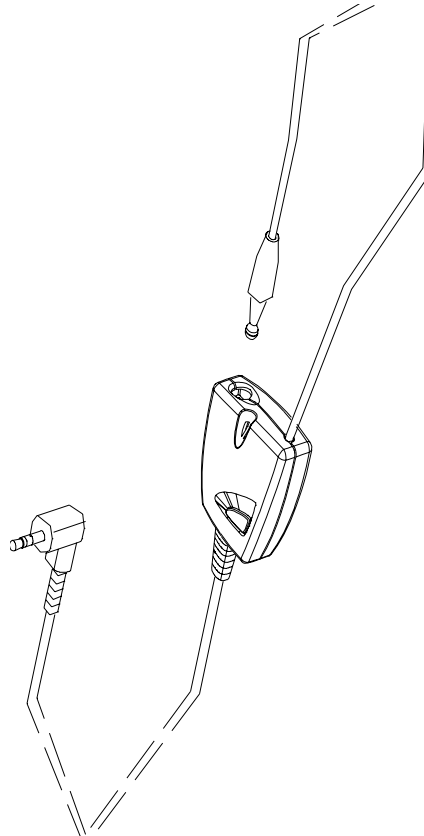

Recommended Batteries

Note (1): The capacity of the zinc air battery will fall 20% in a month. After activation, the zinc air battery begins to self-discharge. The battery will be empty within five weeks.

Type	Size / IEC-type	Rated capacity	Talk time (3mA load)	Standby
Zinc Air Hearing Aid Battery	675 / PR44	540 mAh	180 hrs	840 hrs or 35 days ⁽¹⁾
Silver Oxide Hearing Aid Battery	675 / SR44	150 mAh	50 hrs	7,500 hrs or 310 days
Alkaline Battery	675 / LR44	110 mAh	36 hrs	5,500 hrs or 230 days

Note (1): The capacity of the zinc air battery will fall 20% in a month. After activation, the zinc air battery begins to self-discharge. The battery will be empty within five weeks.

HDA-9 TTY Adapter

HDA-9 allows you to connect your mobile phone to a Telecommunications Device for the Deaf (TDD) to make a call in digital mode.

Product Code

HDA-9 TTY Adapter: 0694116

View of HDA-9

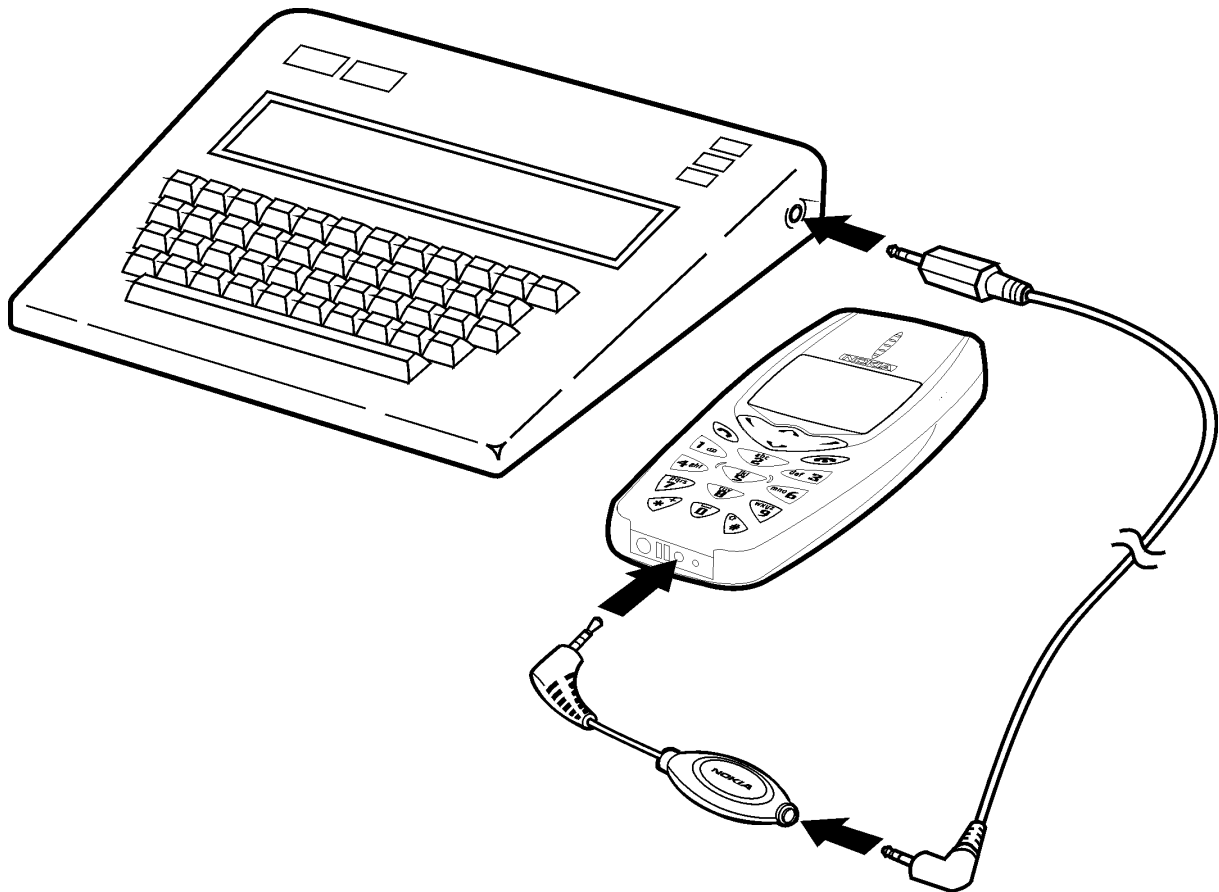

CARK-125 Express Car Kit

This car kit provides charging with handsfree functionality. It is compatible with 12V systems. The Express car kit includes holder, and plug-in handsfree, external microphone. For more information on car kits and installation, see *Chapter 11, Car Kits*.

Product Code

CARK-125 Express Car Kit: 0080381

View of CARK-125

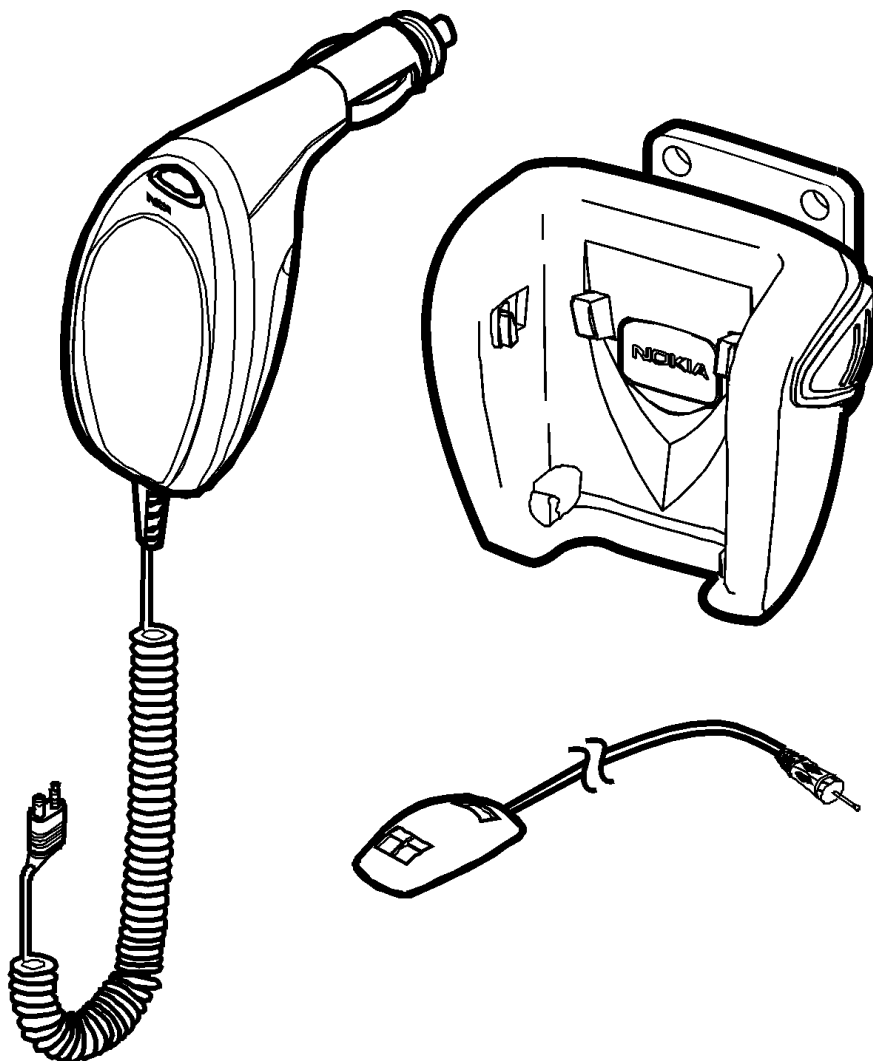

CARK-134 Car Kit

This car kit includes the following components. For more information on car kits and installation, see *Chapter 11, Car Kits*.

Product Code:

CARK-134 Car Kit: 0080641

View of CARK-134

